



# PXE-X120-10DP

## 12-Sound Track High Sound Quality Audio Processor



- For iPhone users, please search "PXE-X120-10DP Tuning APP" in the APP Store to download and install; for Android users, please scan the QR code on the right to download and install the app directly.
- Or you may use a wired controller sold separately for easy control of the device.



Tuning APP







# Contents

<b>Operating Instructions</b>		
Type of precautions .....	2	
<b>Copyright notice</b>		
Copyright notice .....	2	
<b>Repair tool</b>		
Tools that may be required (depending on the vehicle) .....	3	
<b>Accessory list</b>		
Accessory list .....	3	
<b>Device description</b>		
Diagram of device interfaces .....	4	
Description of device interfaces and their functions .....	5	
<b>Wire pin arrangement</b>		
Wire pin arrangement .....	6	
<b>Description of APP</b>		
Description of mobile APP - Homepage (full sound field) .....	8	
Description of mobile APP - Homepage (sound zone) .....	9	
Description of mobile APP - Delay .....	10	
Description of mobile APP - Channel .....	11	
Description of mobile APP - EQ .....	12	
Description of mobile APP - Frequency combination .....	13	
<b>Description of PC software</b>		
Interface of PC software (full sound field) .....	14	
Description of PC software (full sound field) .....	15	
Interface of PC software (sound zone) .....	16	
Description of PC software (sound zone) .....	17	
<b>Technical parameters</b>		
Specifications .....	18	
Functional parameters .....	19	
<b>Information</b>		
Hazardous substances .....	20	
Information of maintenance stations .....	20	

# Operating Instructions

## Type of precautions

 Prohibited	Indicates a prohibited action (must not be performed)
 Prohibited	Indicates that disassembly is prohibited
 Mandatory	Indicates a mandatory operation (must be performed).
	Indicates that it should draw your close attention.

### Warning

#### When a problem occurs, please stop using the device immediately

Otherwise, it may result in personal injury or a damaged product. Please return the product to the authorized Alpine dealer or nearby Alpine service center for repair.

#### The product is only suitable for 12V negative-grounded vehicles.

Otherwise, it may lead to an accident like fire, etc.

#### Please call a professional for wiring and installation

It needs professional expertise and experiences to wire and install the product. Please contact the dealer from whom you bought the product to install it for safety.

#### Please do not disassemble or refit.

Otherwise, it may result in an accident, fire or electric shock.

#### Small items like bolts or screws should be kept out of the reach of child.

If ingested, it may result in severe injury. Once ingested, please seek medical attention immediately.

#### Please do not use any function that may distract you during driving.

Any function that may influence your attention should be

used only when the vehicle is stopped completely. To use these functions, please first stop your vehicle in a safe area. Otherwise, it may result in an accident.

#### When driving, you must maintain the volume at a level such that the noise outside can still be heard.

It is very dangerous not to clearly hear an emergency vehicle alarm and road warning signal (such as a railway crossing) and may result in an accident. Moreover, high volume may damage your hearing.

### Caution

#### Product cleaning

Please clean the product regularly with a soft dry cloth. For any dirt difficult to clean, only water can be used to soak the cloth. Any other solvents may lead to dissolution.

#### Temperature

Before starting the device, please ensure that the temperature inside the vehicle is between +60°C and -20°C.

#### Repair

In case of problems, please do not repair them by yourself. Please return the product to the authorized Alpine dealer or nearby Alpine service center for repair.

#### System matching

When PXE-X120-10DP is used with active division mode to assign signals for speakers, please ensure that the frequency division point of high pitch is above 1500 Hz to avoid damage to high pitch speakers

#### Installation site

The device cannot be installed at the following locations:





- Under direct sunlight and near a hot source
- Places with very high humidity or near a water source
- Dusty sites
- Environments with violent vibration

## Copyright notice





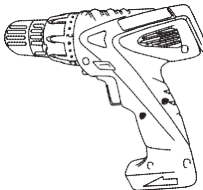
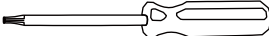
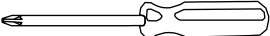
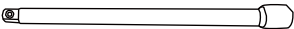
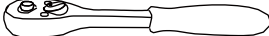
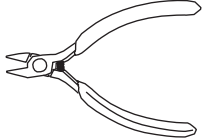

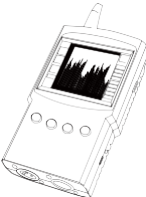
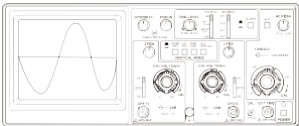
The text mark and logo of Bluetooth® are the registered trademarks held by Bluetooth SIG, Inc. Alpine Electronics has been authorized to use these text mark and logo. Other trademarks and names all belong to their holders.

\* Electronic products should be discarded via an appropriate recycling channel to reduce electronic waste pollution.

# Tools that may be required

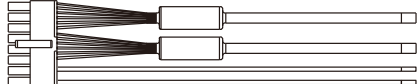
Panel removal tool	Socket	Electric drill	Torx screwdriver
			
Phillips screwdriver	Sleeve wrench	Wrench	Wire cutter
			
Wire crimper	Wire stripper	Spectrum analyzer	Oscilloscope
			

# Accessory list

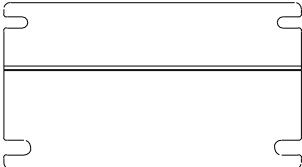
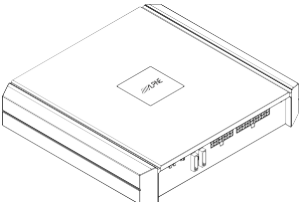
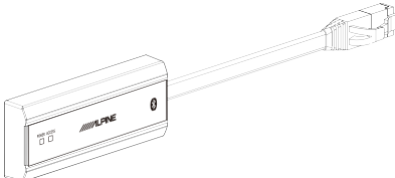
2×13P Input line	2×12P Input line	2×8P Power cord
		
USB 2.0 cable	Machine tooth screw ×4	Self-tapping screw ×4
		
Mounting bracket	Host machine	Bluetooth
		

# Diagram of device interfaces

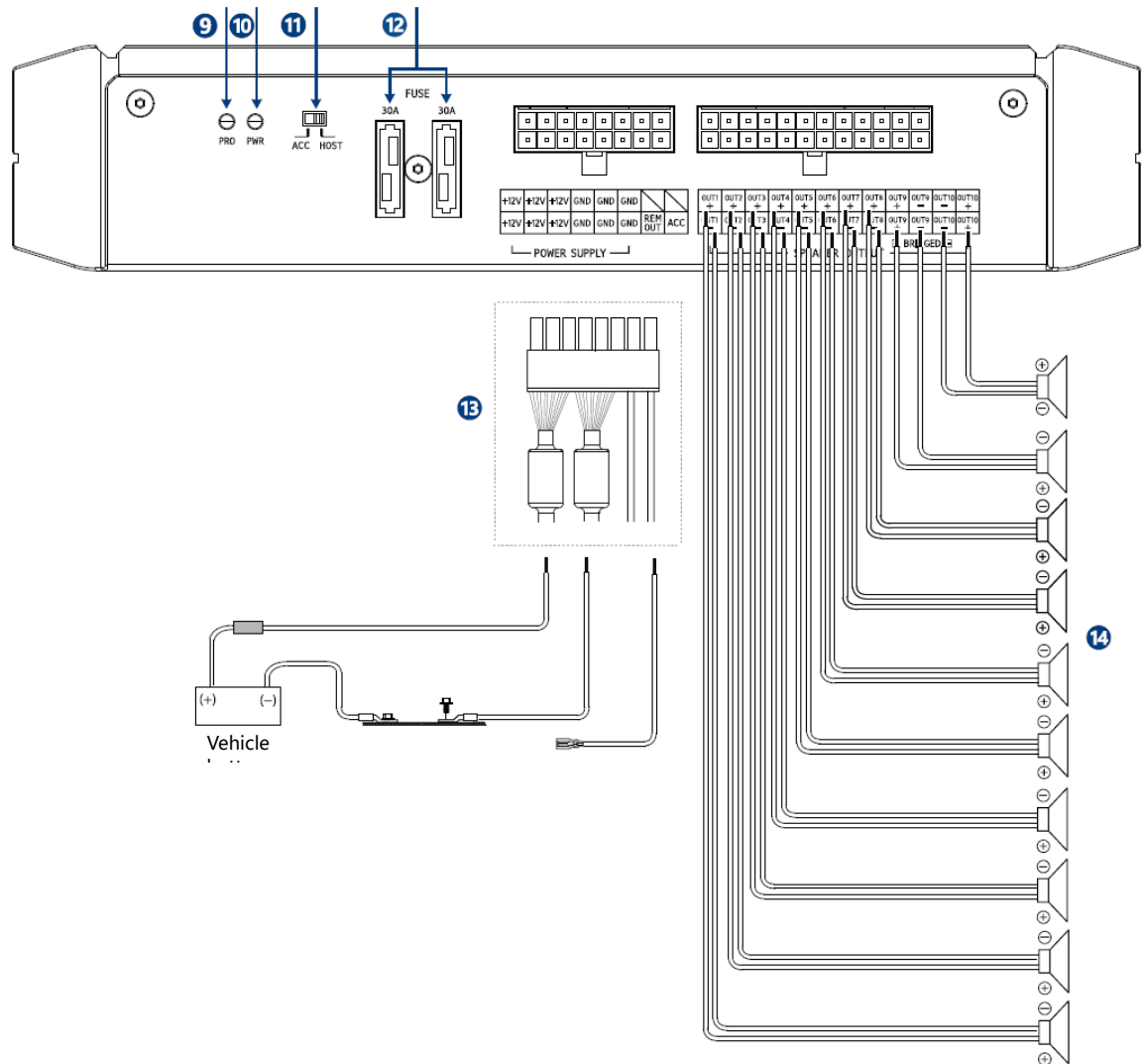
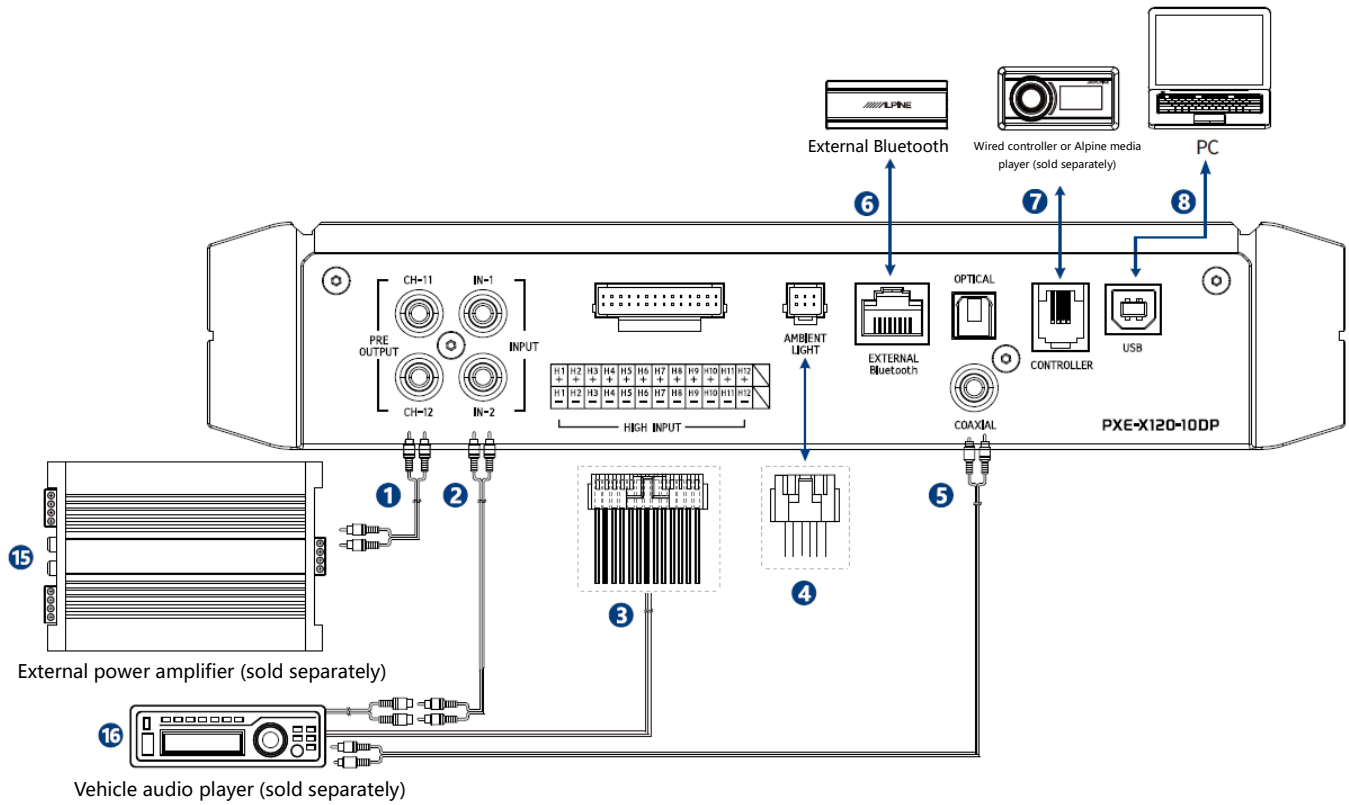

## Description of device interfaces and their functions

1	RCA audio output interface	One set of RCA audio signal output which can be connected to the external power amplifier.
2	RCA audio input interface	One set of RCA audio signal input which can be connected to the RCA audio signal output of the vehicle audio player.
3	High level input interface	Connected to the high level output of the vehicle audio player.
4	Ambient light interface	Connecting the ambient light interface to control the operation of ambient light.
5	Optical/Coaxial input interface	Connecting the optical fiber cable or coaxial cable of the vehicle audio player and switch the audio source of the device to a digital signal input to play optical or coaxial digital signals.
6	External Bluetooth input interface	When High-Definition Bluetooth is selected as the input signal or PXE-X120-10DP mobile Tuning APP is successfully connected, the Bluetooth icon is constant on.
7	Wired controller interface	A system extension interface.
8	USB 2.0 interface	A USB 2.0 cable can be used to connect the computer and perform tone tuning and setting in detail.
9	Protection display lamp	Protection display lamp.
10	Power display lamp	Power display lamp.
11	Input switch interface	If the switch is put to "ACC", the device will be started by ACC; if put to "HOST", the device will be started by the high voltage level input signal H1-/H1+.
12	Fuse socket	Two 30A fuses.
13	Power interface	Connect the vehicle battery.
14	High level input interface	Connect the power amplifier output of the device to speakers.
15	External power amplifier	Connect the external power amplifier
16	Vehicle audio player	Connect the vehicle audio player.

# Wire pin arrangement

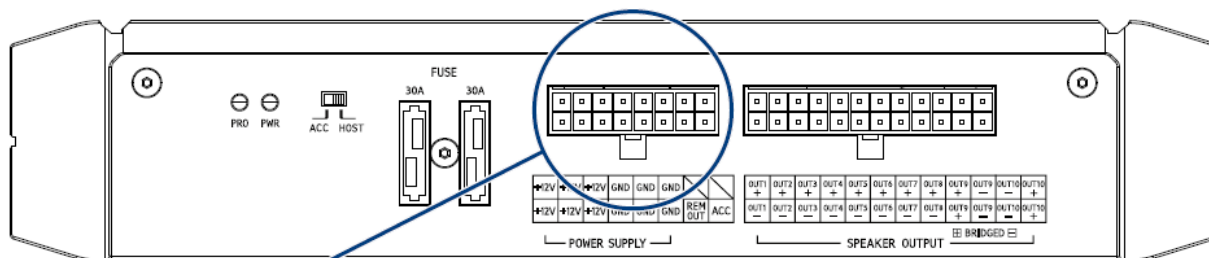

8	9	Yellow 16AWG	+12V
7	10	Yellow 16AWG	+12V
6	11	Yellow 16AWG	+12V
5	12	Black 16AWG	GND
4	13	Black 16AWG	GND
3	14	Black 16AWG	GND
2	15	Blue/White 20AWG	REM OUT
1	16	Red 20AWG	ACC
			NC

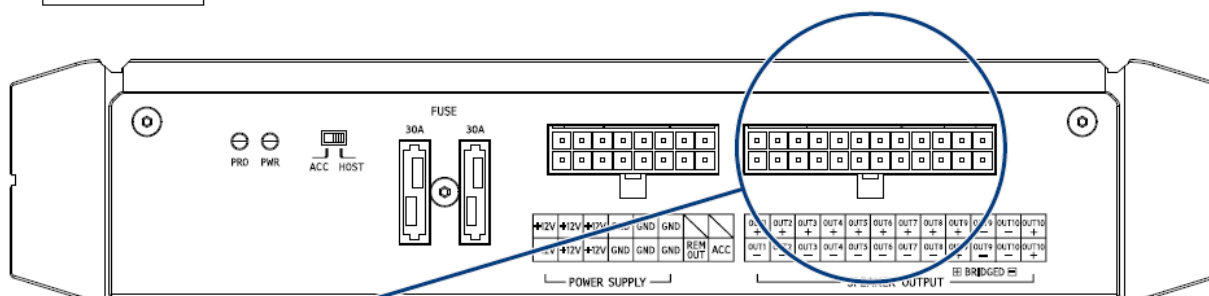

12	13	White/Black 20AWG	Output channel 1-
11	14	White 20AWG	Output channel 1+
10	15	White/Black 20AWG	Output channel 2-
9	16	White 20AWG	Output channel 2+
8	17	White/Black 20AWG	Output channel 3-
7	18	White 20AWG	Output channel 3+
6	19	White/Black 20AWG	Output channel 4-
5	20	White 20AWG	Output channel 4+
4	21	White/Black 20AWG	Output channel 5-
3	22	White 20AWG	Output channel 5+
2	23	White/Black 16AWG	Output channel 6-
1	24	White 16AWG	Output channel 6+
		White/Black 16AWG	Output channel 7-
		White 16AWG	Output channel 7+
		White/Black 16AWG	Output channel 8-
		White 16AWG	Output channel 8+
		White/Black 16AWG	Output channel 9-
		White 16AWG	Output channel 9+
		White/Black 16AWG	Output channel 10-
		White 16AWG	Output channel 10+



# Wire pin arrangement

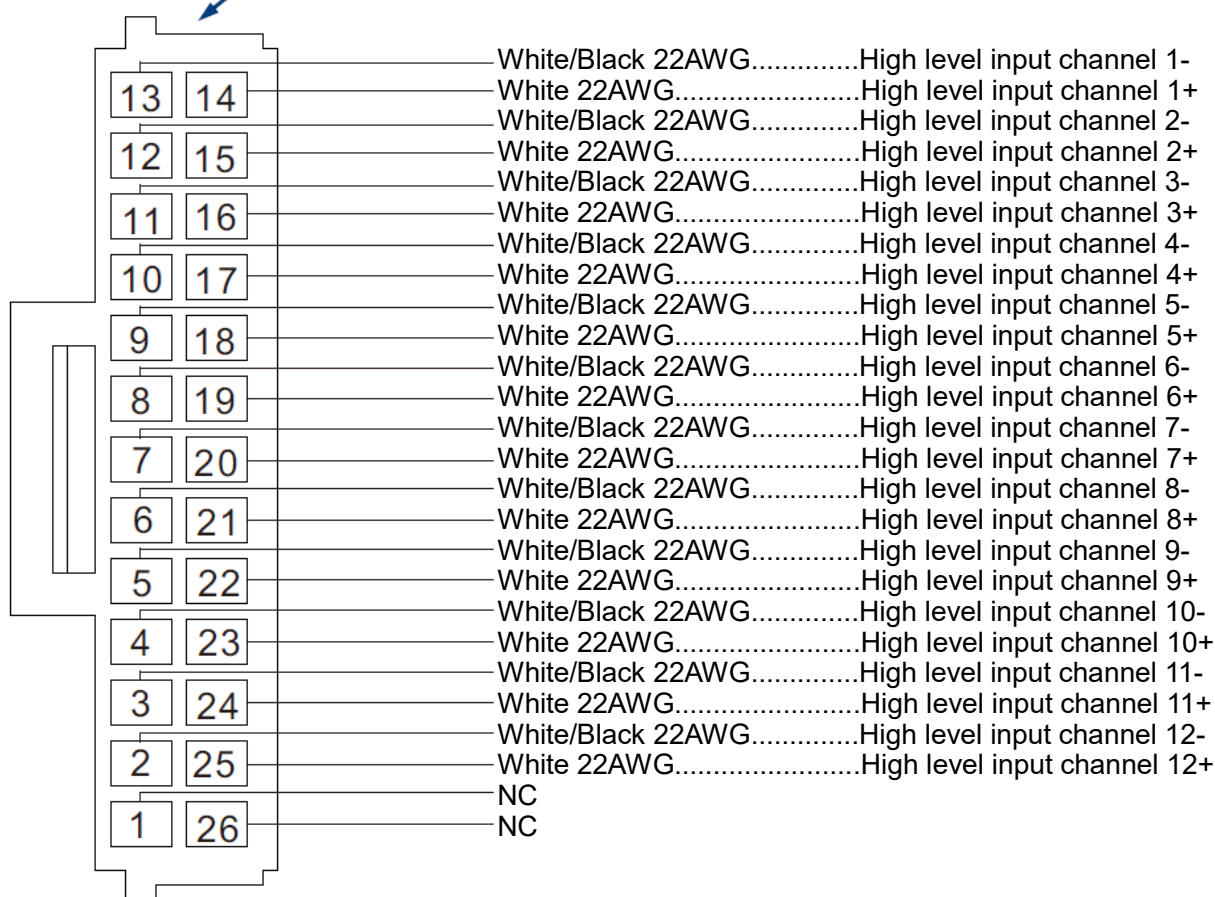
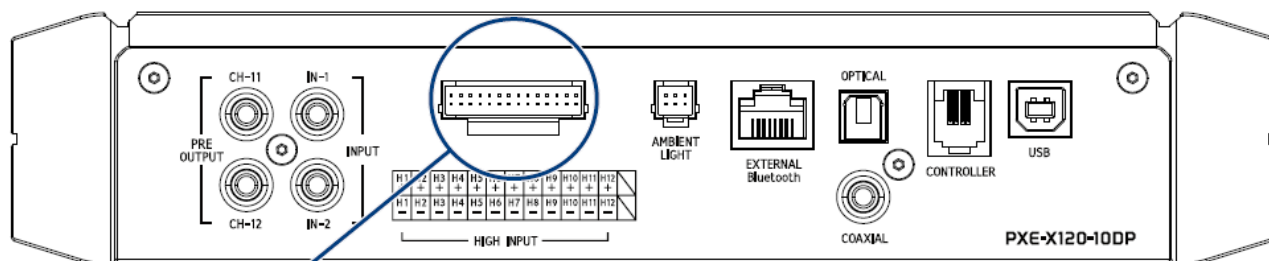

# Description of mobile APP - Homepage (full sound field)

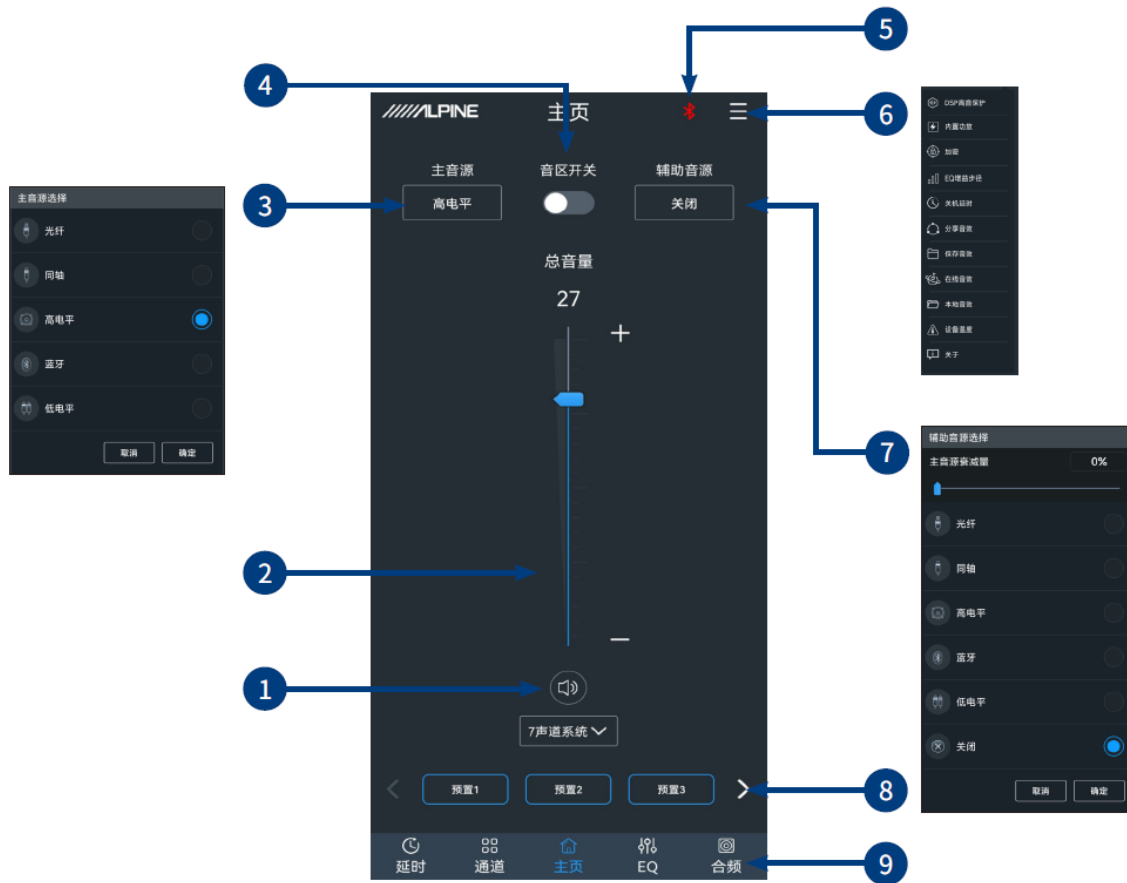

1	Mute button	Mute the master volume
2	Master volume	Pull the fader up and down to adjust the master volume.
3	Master audio source	Switch master audio source (optical, coaxial, high level, Bluetooth and low level).
4	Sound zone switch	Switch sound zone on or off (off by default).
5	Connection indication	When the Bluetooth icon is red, the mobile phone Bluetooth is not connected; when it is green, the mobile phone Bluetooth is connected.
6	Menu bar	You can set DSP high pitch protection, built-in sound effect switch, data encryption, EQ gain step, shutdown delay, share sound effects, save sound effects, online sound effects, local sound effects, set temperature and view version number.
7	Auxiliary audio source	Switch auxiliary audio source (optical, coaxial, high level, Bluetooth and low level); the more the attenuation of master audio source, the lower the master sound volume, range of attenuation: 0%~100%.
8	Pre-set sound effects	Save and call multiple pre-set sound effect data, slide left and right to select different preset sound effect data.
9	Page selection	There are 5 pages of different functions, Delay, Channel, Homepage, EQ, and Frequency combination, and the device goes to Homepage (full sound field) by default.

Caution: the Bluetooth audio source and low level audio source are mutually exclusive and cannot be superposed.

# Description of mobile APP - Homepage (sound zone)



Click to turn on the sound zone switch in Homepage for sound zone setting, you can match the audio sources of the front and rear sound fields of sound zone I and sound zone II flexibly and freely. For example, set front sound field of sound zone I to CH1~CH6 and select high level as master audio source, set rear sound field of sound zone II to CH7~CH12 and select optical as master audio source, then CH1~CH6 of front sound field will play music from high level audio source and CH7~CH12 of rear sound field will play music from optical audio source, such that audio sources of front and rear sound fields are matched flexibly and freely.

When sound zone switch is turned on, the sound zone interface is shown in the figure above

1	Sound zone I	Select sound zone I and you can switch master audio source of sound zone I (optical, coaxial, high level, Bluetooth, and low level), switch auxiliary audio source (optical, coaxial, high level, Bluetooth, low level and off), select channel, adjust sound volume (range 0~35) and set attenuation of master audio source (range 0~100).
2	Sound zone II	Select sound zone II and you can switch master audio source (optical, coaxial, high level, Bluetooth and low level), select channel, and adjust sound volume (range 0~35).

## Caution:

1. The master audio source and auxiliary audio source of sound zone I are mutually exclusive, that is, the auxiliary audio source and the current master audio source input cannot be superimposed; otherwise the auxiliary audio source will be invalid (optical and coaxial are both digital audio sources and cannot be superimposed);
2. The channels of sound zone I and sound zone II are mutually exclusive. If CH1~CH6 are selected as channel of sound zone I, CH1~CH6 will be invalid for sound zone II.

# Description of mobile APP - Delay

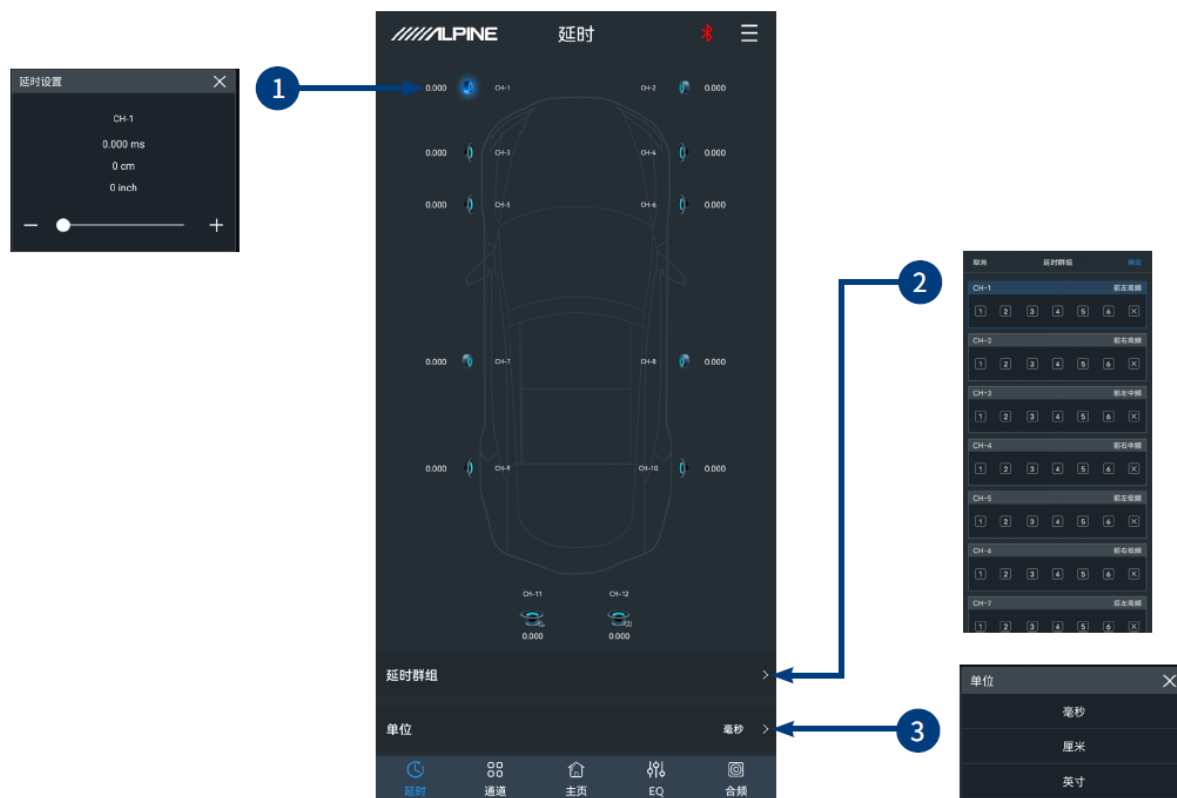

1	Speaker	Select the corresponding speaker, push the fader left and right on the pop-up window to adjust the delay, or click "+" and "-" to adjust the delay.
2	Delay group	There are 6 delay groups to choose from for each channel.
3	Unit of delay	Units of delay to choose from include ms, cm, and in. Adjusting range: 0.000~20.000 ms, 0~692 cm, 0~273 in.

# Description of mobile APP - Channel

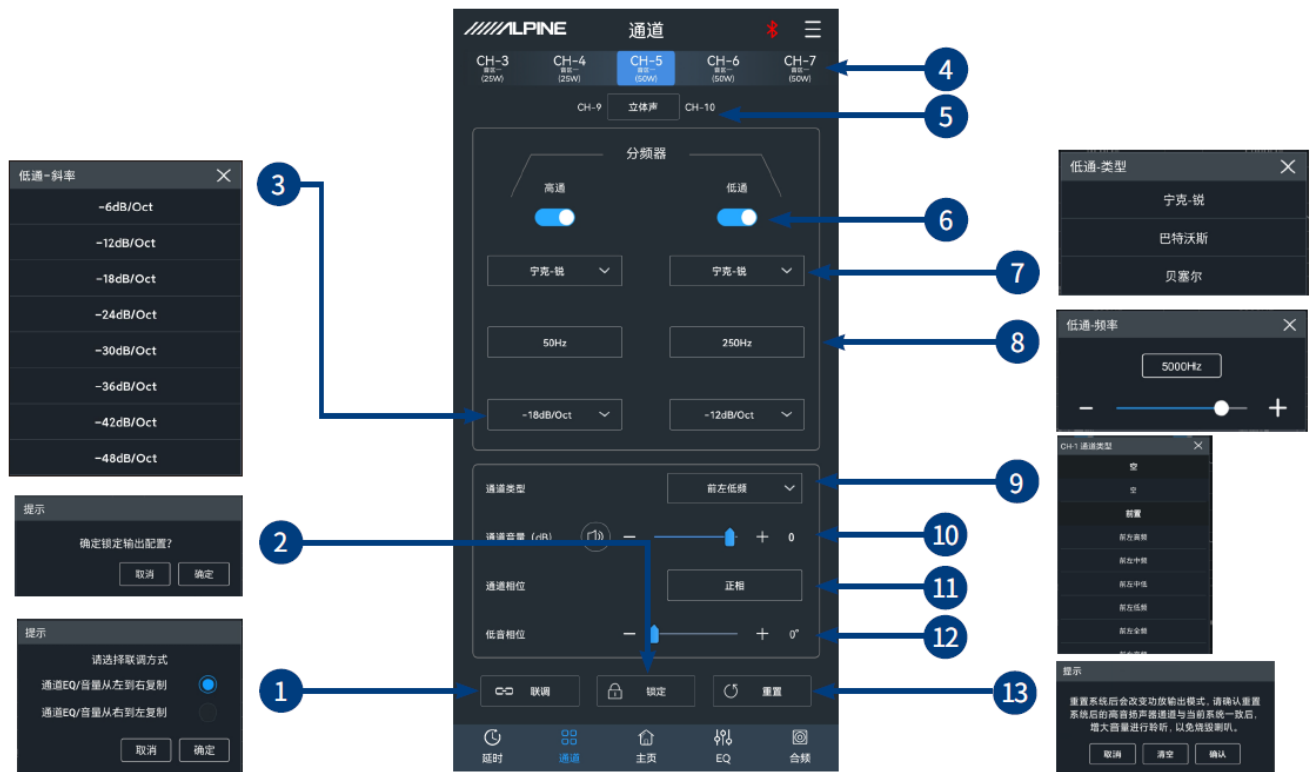

1	Debugging	The debugging modes to choose from include "Copy channel EQ / volume from left to right" or "Copy channel EQ / volume from right to left".
2	Locking	You can lock the current channel type.
3	Slope	Select the divider slope (-6dB/Oct, -12dB/Oct, -18dB/Oct -24dB/Oct -30dB/Oct, -36dB/Oct, -42dB/Oct, or -48dB/Oct).
4	Output channel	Slide left and right to select the output channel to set. There are 12 channels to choose from.
5	Bridging	Bridging and Stereo selection between CH9/CH10
6	Divider	Turn on or off High-pass/Low-pass.
7	Filter type	Select filter type (Linkwitz-Riley, Butterworth or Bessel)
8	Divider frequency	Select the divider frequency (between 20Hz and 20kHz).
9	Channel type	Select the channel type in the pull-down menu.
10	Channel volume	Push and fader left and right to adjust the channel volume in the range of -60dB~6dB; click the speaker button to mute.
11	Channel phase	Select the channel phase (normal phase or reverse phase).
12	Low pitch phase	Adjust the low pitch phase of output channel in the range of 0°~360°.
13	Reset channel type	Select "Clear" to set the current channel type as Empty; select "OK" to set the current channel type as Factory setting.

# Description of mobile APP - EQ

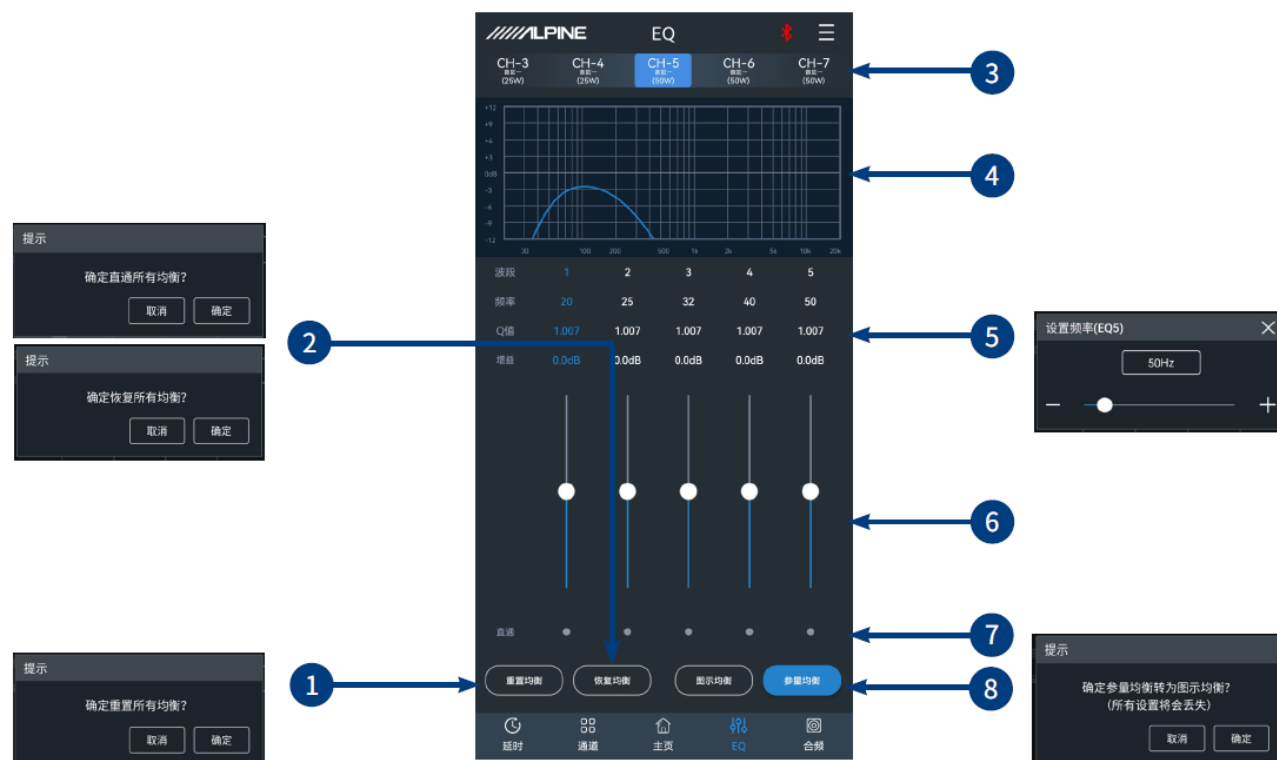

1	Reset EQ	Reset EQ setting.
2	Restore EQ, Direct EQ	Switch the tuned EQ data to direct state, click it again to restore the EQ data before Direct EQ setting.
3	Output channel	Slide left and right to select the output channel for EQ adjustment. There are 12 channels to choose from.
4	EQ display	Display the EQ adjustment curve.
5	Frequency, Q value, Gain	Adjust the frequency, Q value and gain of the output channel. The gain is adjustable but the frequency and Q value are fixed in the Graphic EQ interface. The frequency, Q value and gain are all adjustable in the Parametric EQ interface.
6	Gain	Pull the fader up and down to adjust the gain. The adjustable range is: -12.0dB~+12.0dB.
7	Waveband ON/OFF	Switch the tuned EQ data of the current waveband to the direct state, and click it again to restore the EQ data before the Direct EQ setting.
8	Parametric EQ, Graphic EQ	Switch between Parametric EQ mode and Graphic EQ mode. Mode switch would lead to loss of all settings.

# Description of mobile APP - Frequency combination

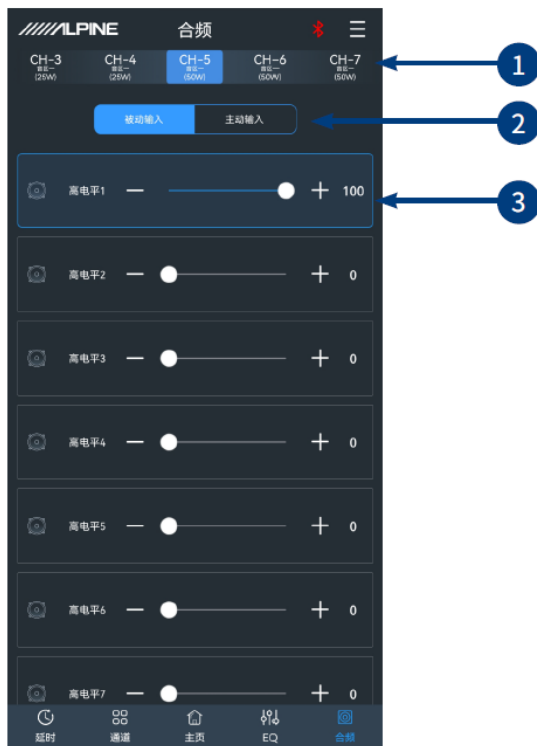

1	Output channel	Slide left and right to select the output channel for combined frequency setting. There are 12 channels to choose from.
2	Active or passive input	Keep the default setting as "Passive". Warning: if changed, you will lose the sound mixer setting of this channel.
3	Input channel	Push the fader left and right or press "+" and "-" to adjust the volume of each audio source in the channel to achieve the purpose of sound mixing and frequency mixing.

Caution: It is strongly recommended to set the total volume of a channel to 100 to avoid clipping.

# Interface of PC software (full sound field)

The main software interface for the ALPINE PXE-X120-10DP is shown with 25 numbered callouts pointing to various features:

- 1: Power button
- 2: Temperature display (0°C)
- 3: Volume slider
- 4: EQ gain slider (0.1dB)
- 5: Zone switch
- 6: Home button
- 7: EQ button
- 8: Delay button
- 9: Main menu button
- 10: EQ button
- 11: Delay button
- 12: Settings button
- 13: Channel list (CH-1 to CH-12)
- 14: Frequency response graph (30-20K Hz)
- 15: Filter parameters table (Waveform, Frequency, Q, Gain, Phase)
- 16: Filter type selection (Parametric EQ)
- 17: High-pass filter settings (Type, Frequency, Slope)
- 18: Low-pass filter settings (Type, Frequency, Slope)
- 19: Phase setting (0°)
- 20: Gain setting (0dB)
- 21: Phase setting (0°)
- 22: Filter type selection (Parametric EQ)
- 23: Filter type selection (Parametric EQ)
- 24: Channel list (CH-1 to CH-12)
- 25: Power button

9

This screenshot shows the main menu and channel selection options. It includes buttons for "Main Menu", "EQ", "Delay", and "Settings". Below these are options for "Main Source Selection" (FM, AM, Bluetooth, CD, USB) and "Auxiliary Source Selection" (FM, AM, Bluetooth, CD, USB). There are also buttons for "Channel Selection" (Channel 1 to Channel 4) and "Channel 5" (Channel 5).

11

This screenshot shows the channel configuration screen. It features a central car diagram with 12 channels (CH-1 to CH-12) labeled. Each channel has a corresponding control panel with buttons for "Channel Selection", "Gain", "Phase", and "Filter". The channels are arranged as follows: CH-1 (Front Left), CH-2 (Front Right), CH-3 (Front Left Mid), CH-4 (Front Right Mid), CH-5 (Front Left Low), CH-6 (Front Right Low), CH-7 (Rear Left High), CH-8 (Rear Right High), CH-9 (Rear Left Low), CH-10 (Rear Right Low), CH-11 (Left Subwoofer), and CH-12 (Right Subwoofer).

12

This screenshot shows the channel configuration screen with a detailed table of settings for each channel. The table has columns for Channel, Gain, Phase, and Filter. The settings are as follows:

Channel	Gain	Phase	Filter
高前左1	100	0	0
高前右1	100	0	0
高前左2	100	0	0
高前右2	100	0	0
高前左3	100	0	0
高前右3	100	0	0
高前左4	100	0	0
高前右4	100	0	0
高前左5	100	0	0
高前右5	100	0	0
高前左6	100	0	0
高前右6	100	0	0
高前左7	100	0	0
高前右7	100	0	0
高前左8	100	0	0
高前右8	100	0	0
高前左9	100	0	0
高前右9	100	0	0
高前左10	100	0	0
高前右10	100	0	0
高前左11	100	0	0
高前右11	100	0	0
高前左12	100	0	0
高前右12	100	0	0
高前左13	100	0	0
高前右13	100	0	0
高前左14	100	0	0
高前右14	100	0	0
高前左15	100	0	0
高前右15	100	0	0
高前左16	100	0	0
高前右16	100	0	0
高前左17	100	0	0
高前右17	100	0	0
高前左18	100	0	0
高前右18	100	0	0
高前左19	100	0	0
高前右19	100	0	0
高前左20	100	0	0
高前右20	100	0	0
高前左21	100	0	0
高前右21	100	0	0
高前左22	100	0	0
高前右22	100	0	0
高前左23	100	0	0
高前右23	100	0	0
高前左24	100	0	0
高前右24	100	0	0
高前左25	100	0	0
高前右25	100	0	0
高前左26	100	0	0
高前右26	100	0	0
高前左27	100	0	0
高前右27	100	0	0
高前左28	100	0	0
高前右28	100	0	0
高前左29	100	0	0
高前右29	100	0	0
高前左30	100	0	0
高前右30	100	0	0
高前左31	100	0	0
高前右31	100	0	0



# Description of PC software (full sound field)

1	Temperature display	Detect the temperature on the device surface.
2	File	Load or save scene files on PC, load or save all scene files.
3	Options	DSP high pitch protection, firmware update, noise gate, built-in power amplifier, restore factory settings, shutdown delay, switch between English and Chinese, check the version number.
4	Encryption	Enter a 6-digit password to encrypt the tuned sound effect data.
5	EQ gain step size	Step size can be chosen from the range: 0.1dB ~ 0.5dB ~ 1.0dB.
6	Mute button	Mute the master volume
7	Master volume	Pull the fader left and right to adjust the master volume.
8	Sound zone switch	Switch sound zone on or off (off by default).
9	Homepage	Selection of master audio source (optical, coaxial, high level, Bluetooth and low level). Selection of auxiliary audio source (optical, coaxial, high level, Bluetooth, low level and off). Adjustment of master audio source attenuation (adjustable range 0~100%). Save or call multiple sets of pre-set sound effects, support call of online sound effects.
10	EQ	Enter the EQ interface, professional tuning interface.
11	Delay	Enter the Delay interface, set the delay value, unit of delay and delay group.
12	Frequency combination	Enter the Frequency Combination interface, set Sound Mixing and Frequency Mixing.
13	Output channel display	Display the output channel curve.
14	EQ curve	Display the current EQ curve status, set the frequency, Q value and gain.
15	Frequency, Q value, Gain	Adjust the frequency, Q value and gain of the output channel. The gain is adjustable but the frequency and Q value are fixed in the Graphic EQ interface. The frequency, Q value and gain are all adjustable in the Parametric EQ interface.
16	Parametric EQ, Graphic EQ	Switch between Parametric EQ mode and Graphic EQ mode. Mode switch would lead to loss of all settings.
17	Low-pass filter	Turn on or off the low-pass filter to cut off high frequency. Select filter type (Linkwitz-Riley, Butterworth or Bessel) Select the divider frequency (between 20Hz and 20kHz). Select the divider slope (-6dB/Oct, -12dB/Oct, -18dB/Oct -24dB/Oct -30dB/Oct, -36dB/Oct, -42dB/Oct, or -48dB/Oct).
18	High-pass filter	Turn on or off the high-pass filter to cut off low frequency. Select filter type (Linkwitz-Riley, Butterworth or Bessel) Select the divider frequency (between 20Hz and 20kHz). Select the divider slope (-6dB/Oct, -12dB/Oct, -18dB/Oct -24dB/Oct -30dB/Oct, -36dB/Oct, -42dB/Oct, or -48dB/Oct).
19	Channel phase	Select the channel phase (normal phase or reverse phase).
20	Low pitch phase	Adjust the low pitch phase of output channel in the range of 0°~360°.
21	Channel gain	Push the fader left and right to adjust the channel gain, that it, to adjust the volume of the output channel; the adjustable range is: -60dB~+6dB.
22	Direct EQ, Restore EQ	Switch the tuned EQ data to direct state, click it again to restore the EQ data before Direct EQ setting.
23	Reset EQ	Reset EQ setting.
24	Output channel	There are 12 output channels to choose from. Configure the type of output channel. Click the speaker button to mute.
25	Connection indication	Connect the PC and the host machine with a USB cable. Open the software to connect the device. Click it again to turn off the connection.

# Interface of PC software (sound zone)

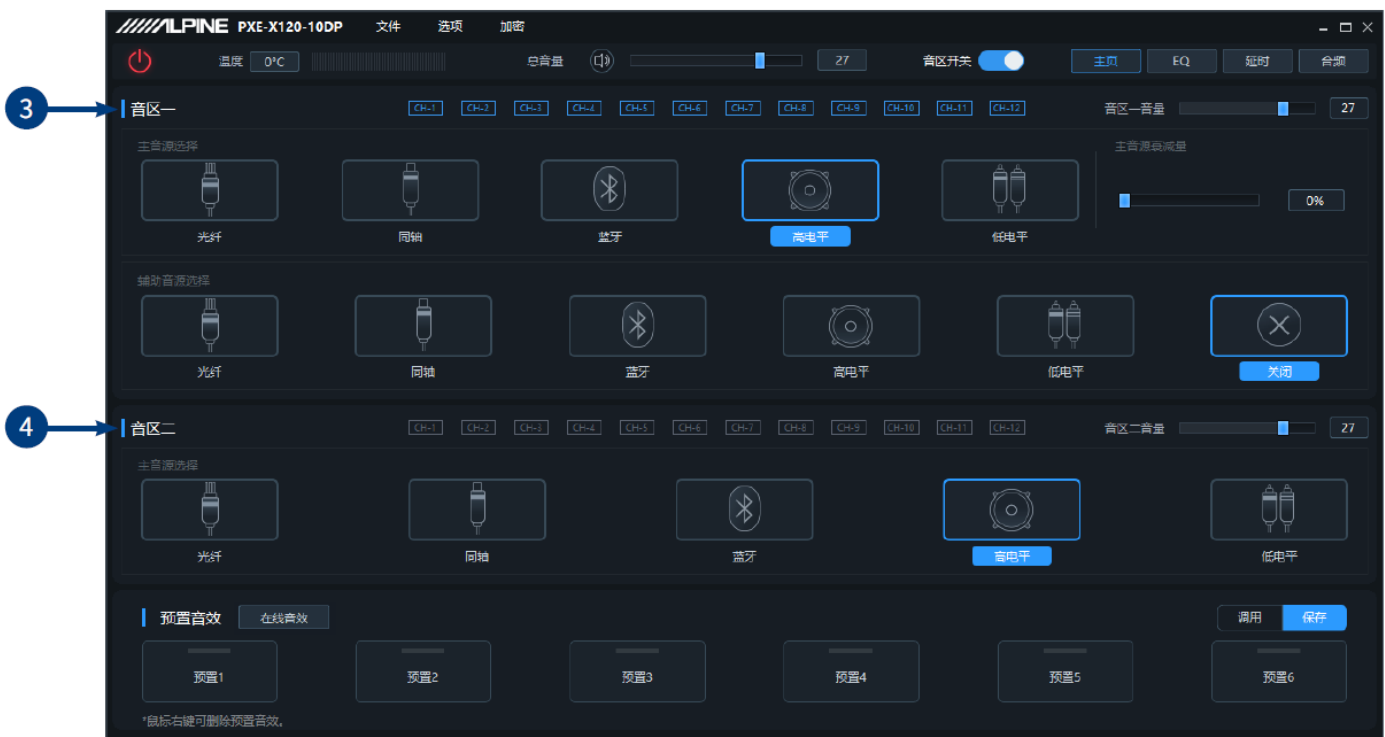
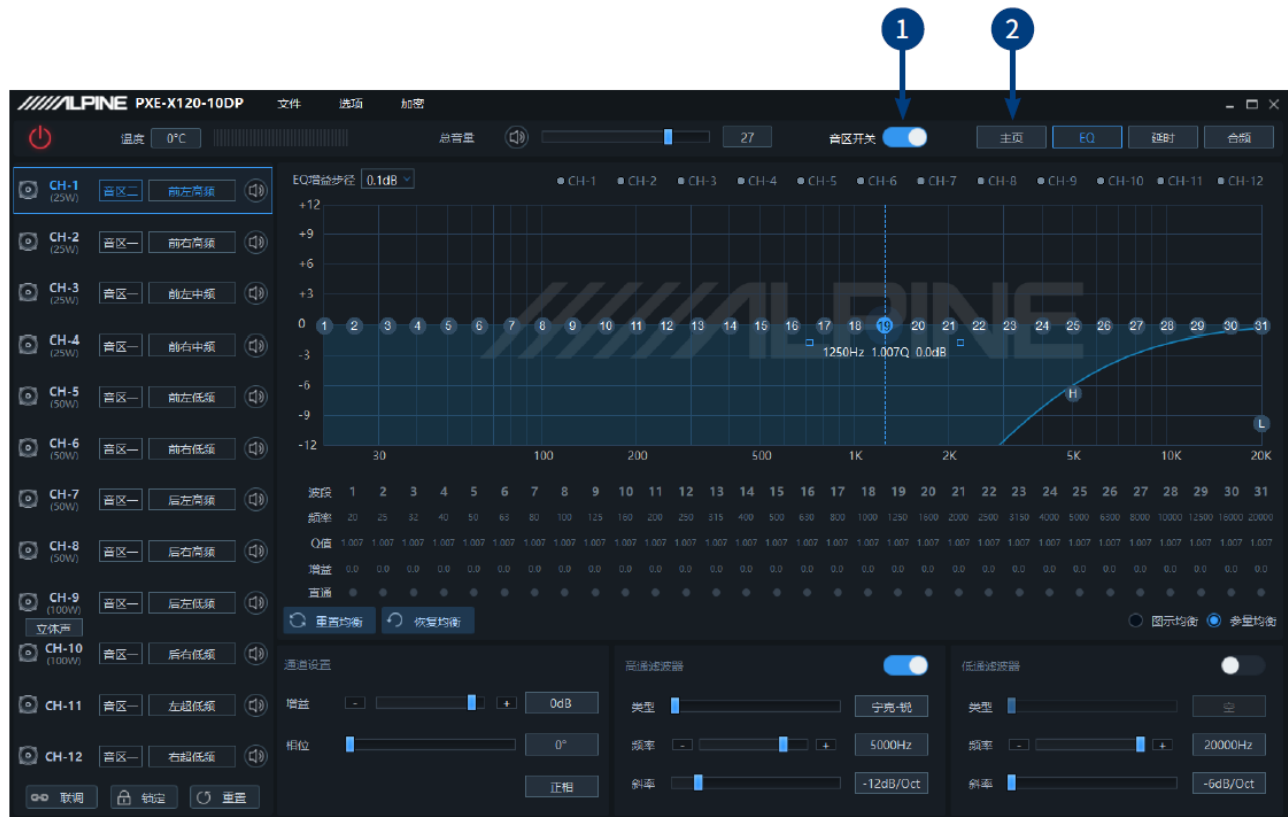

# Description of PC software (sound zone)

When sound zone switch is turned on, the sound zone interface is shown in the figure above

1	Sound zone switch	Turn on sound zone switch to make sound zone settings.
2	Homepage	You can match the audio sources of the front and rear sound fields of sound zone I and sound zone II flexibly and freely on the Homepage. For example, set front sound field of sound zone I to CH1~CH6 and select high level as master audio source, set rear sound field of sound zone II to CH7~CH12 and select optical as master audio source, then CH1~CH6 of front sound field will play music from high level audio source and CH7~CH12 of rear sound field will play music from optical audio source, such that audio sources of front and rear sound fields are matched flexibly and freely.
3	Sound zone I	Select sound zone I and you can switch master audio source of sound zone I (optical, coaxial, high level, Bluetooth, and low level), switch auxiliary audio source (optical, coaxial, high level, Bluetooth, low level and off), select channel, adjust sound volume (range 0~35) and set attenuation of master audio source (adjustable range 0~100).
4	Sound zone II	Select sound zone II and you can switch master audio source (optical, coaxial, high level, Bluetooth and low level), select channel, and adjust master sound volume (range 0~35).

## Caution:

1. The master audio source and auxiliary audio source of sound zone I are mutually exclusive, that is, the auxiliary audio source and the current master audio source input cannot be superimposed; otherwise the auxiliary audio source will be invalid (optical and coaxial are both digital audio sources and cannot be superimposed);
2. The channels of sound zone I and sound zone II are mutually exclusive. If CH1~CH6 are selected as channel of sound zone I, CH1~CH6 will be invalid for sound zone II.

# Specification parameters

Dynamic range	≥100dB
Signal to noise ratio (RCA)	≥100dB
Background noise	High level CH1~CH4: 58uVrms, CH5~CH8: 113uVrms, CH9~CH10: 115uVrms; RCA: 8.8uVrms
Channel resolution	≥80dB
THD	≤0.01%
Input voltage	High level: 30Vpp; RCA: 6.5Vpp
Output voltage	High level CH1~CH4: 28Vpp, CH5~CH8: 40Vpp, CH9~CH10: 58Vpp; RCA: 8Vpp
Rated power	CH1~CH4: 25W, CH5~CH8: 50W, CH9~CH10: 100W (4Ω, 14.4V, 1kHz, 10%THD), Bridging CH9~CH10: 1CH×200W (4Ω, 14.4V, 1kHz, 10%THD)
Maximum power	CH1~CH4: 50W, CH5~CH8: 100W, CH9~CH10: 200W (4Ω, 14.4V, 1kHz, 10%THD), Bridging CH9~CH10: 1CH×400W (4Ω, 14.4V, 1kHz, 10%THD)
Input/output sensitivity (RCA)	1:1.23 (no power amplification)
Frequency response	20Hz ~ 20kHz
System sampling rate	48kHz/24bit
Input impedance	High level: 18Ω; RCA: 15kΩ
Output impedance	51Ω
Working voltage	9~16V
Quiescent current	≤3mA (in off state)
Stand-by power consumption	≤0.1W
REM startup input	High level (H1-/H1+), ACC optional
REM startup output	12V (0.2A)
Startup time	10s
Operating ambient temperature	-20~60°C
Storage temperature	-40~85°C
Net weight	3.9kg
Dimensions	250mm×234mm×50mm

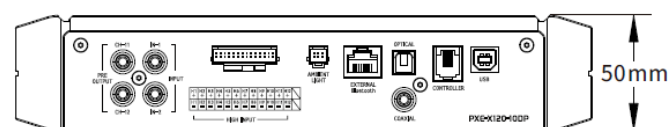
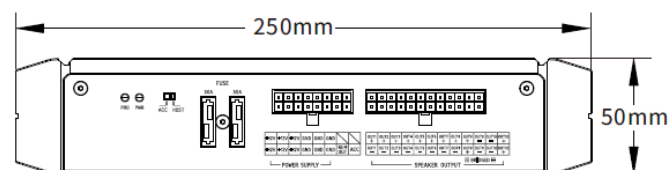
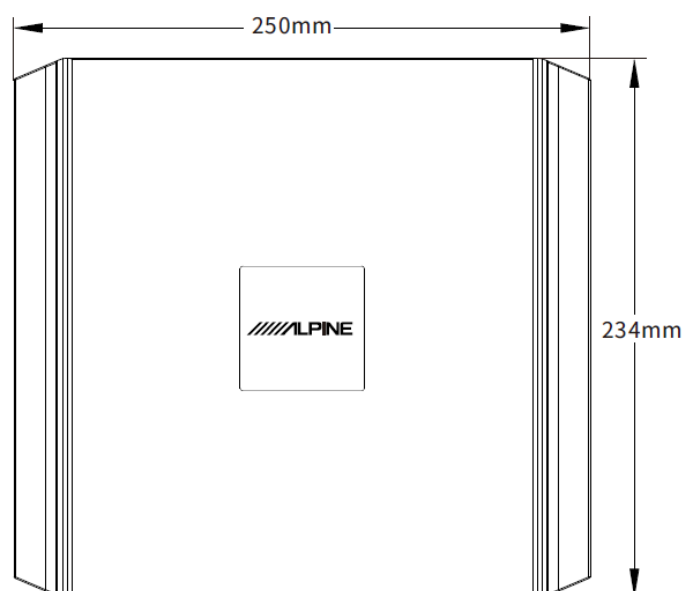

# Functional parameters

Input signals	12-Channel high level, 2-channel RCA audio, high-definition Bluetooth, optical/coaxial
Output signals	10-Channel high level, 2-channel RCA audio
Signal gain of output channel	Range: mute, -60dB~+6dB
Output signal equalizer	Type: parametric EQ, graphic EQ Frequency: 20Hz~20kHz, resolution: 1Hz Q value (slope or gradient): 0.404~28.852 Gain: -12.0dB~+12.0dB, resolution: 0.1dB~0.5dB~1.0dB
Output signal frequency divider	Each output channel is equipped with an independent multi-order high-pass filter, Filter type: Linkwitz-Riley, Bessel, Butterworth Filter cross-over frequency: 20Hz~20kHz, resolution: 1Hz Filter slope (gradient): -6dB/Oct~-48dB/Oct
Output phase	Normal phase or reverse phase (0°~360°)
Output delay	0.000~20.000 ms, 0~692 cm, 0~273 inch
Pre-set sound effects	Multiple sets of pre-set sound effects data can be saved in the device, call of online sound effects is supported